

*Parameters Subject to Change Without Notice*

### FEATURES

- 2.5V to 6V operating input range
- Up to 3A output current
- Up to 95% peak efficiency
- Internal Soft-Start
- 1MHz switching frequency
- Input under voltage lockout
- Short circuit latch off protection
- Over voltage latch off protection
- Thermal protection
- Hot-plug in protection
- Output POK indication
- Available in DFN2X2-8package

### APPLICATIONS

- 5V or 3.3V Point of Load Conversion
- Set Top Boxes
- Telecom/Networking Systems
- Storage Equipment
- GPU/DDR Power Supply

### DESCRIPTION

The JW<sup>®</sup>5213 is a current mode monolithic buck switching regulator. Operating with an input range of 2.5V-6V, the JW5213 delivers 3A of continuous output current with integrated P-Channel and N-Channel MOSFETs. The internal synchronous power switches provide high efficiency. At light loads, the regulator operate in low frequency to maintain high efficiency and low output ripples. Current mode control provides tight load transient response and cycle-by-cycle current limit.

The JW5213 guarantees robustness with latch off output short-circuit protection, latch off over-voltage protection, start-up current run-away protection, input under voltage lockout protection, hot-plug in protection, and thermal protection.

### ELECTRICAL SPECIFICATIONS

Parameter	Symbol	Value	Unit
Input Voltage	VIN	2.5~6	V
Output Voltage	VOUT	1.8	V
Output Current	IOUT	0~3	A

### TYPICAL PERFORMANCE

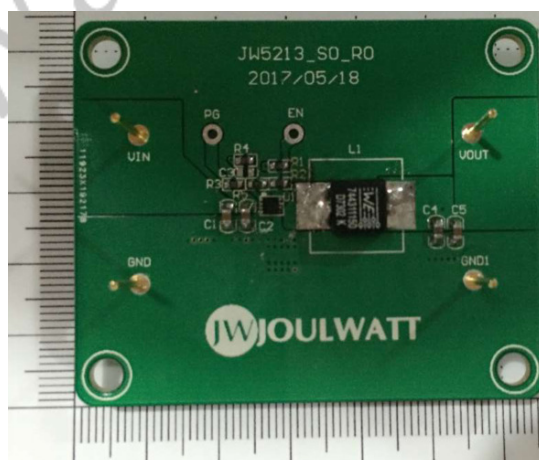

SCHEMATIC

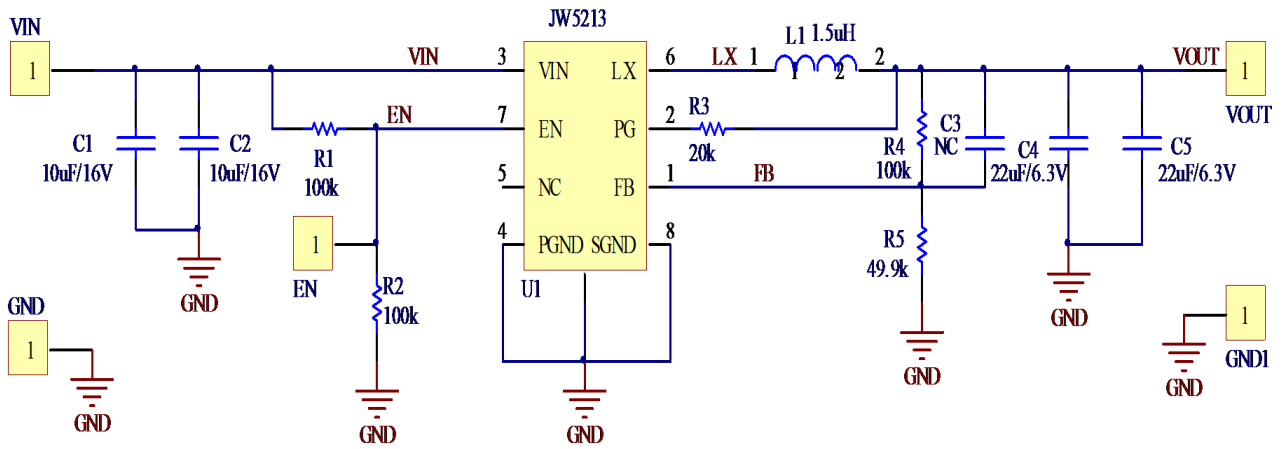

BILL OF MATERIALS

Qty.	Designator	Value	Description	Package	Manufacturer	Manufacturer P/N
2	C1,C2	10uF	Ceramic capacitor 10V ,X7R	0805C	SAMSUNG	CL21A106KOQNNNE
1	C4,C5	22uF	Ceramic capacitor 6.3V ,X7R	0805C	SAMSUNG	CL21A226MQQNNNE
0	C3	NC		0805C	MURATA	GRM1885C1H271JA01
1	L1	1.5uH/4A	Inductor		WürthElektronik	
1	R1,R2,R4	100k	Resistor,5%	0603R	uniohm	0603 J01501T5E
1	R5	49.9k	Resistor,1%	0603R	uniohm	0603 J01501T5E
1	R3	20k	Resistor,5%	0603R	uniohm	0603 J01501T5E
1	VIN	2.5V~6V		TEST-Pole		
1	VOUT	1.8V/3A		TEST-Pole		
1	U1	6V/3A	Buck	DFN2X2-8	Joulwatt	JW5213

## PRINTED CIRCUIT BOARD LAYEROUT

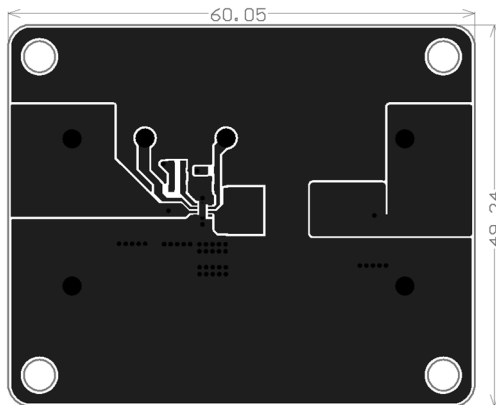

Figure1—Top Layer

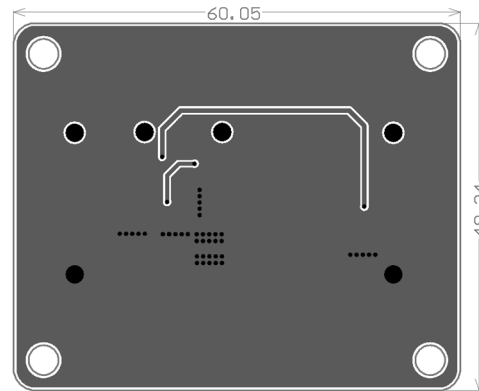

Figure2—Bottom Layer

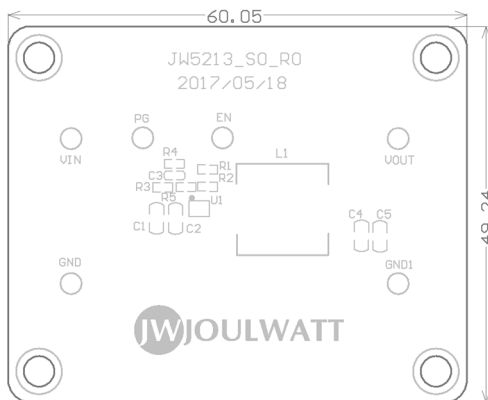

Figure3—Silk Layer

## QUICK START GUIDE

1. Connect the positive terminal and negative terminal of the load to Vout and GND of EVB, respectively.
2. Connect a power supply between VIN and GND with the supply in “OFF” state. Set the output voltage of the power supply to 2.5V~6V.
3. Turn on the power supply and the evaluation board starts operating in normal condition.
4. The output voltage can be adjusted by varying the R2 and R3 on EVB.  
For example: Fixed R3 to 10K, when adjusting the output voltage to 3.3V,  
 $R2 = V_{out} / 0.6 * R3 - R3$ .
5. For more information, please refer to the datasheet of JW5213.

TYPICAL PERFORMANCE CHARACTERISTICS

Vin = 5V, Vout = 1.8V, L = 1.5μH, Cout = 22μFx2, TA = +25°C, unless otherwise noted

Steady State Test

VIN=5V, Vout=1.8V  
Iout=3A

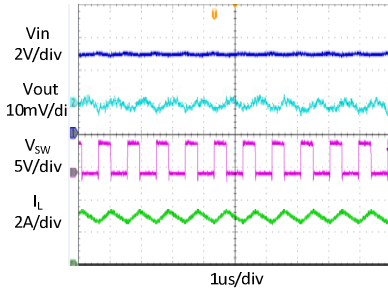

Startup through Enable

VIN=5V, Vout=1.8V  
Iout=3A(Resistive load)

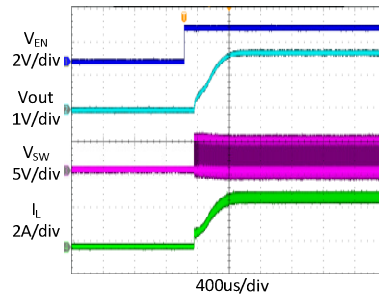

Shutdown through Enable

VIN=5V, Vout=1.8V  
Iout=3A(Resistive load)

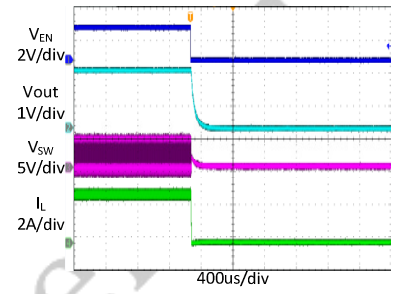

Heavy Load Operation

3A LOAD

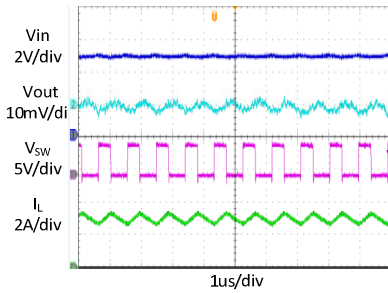

Medium Load Operation

1.5A LOAD

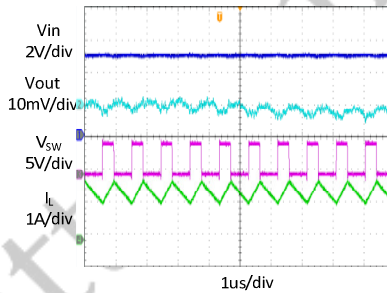

Light Load Operation

0 A LOAD

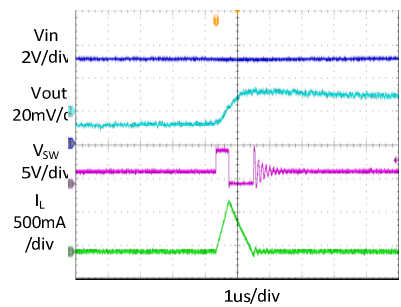

Short Circuit Protection

VIN=5V, Vout=1.8V  
Iout=3A- Short

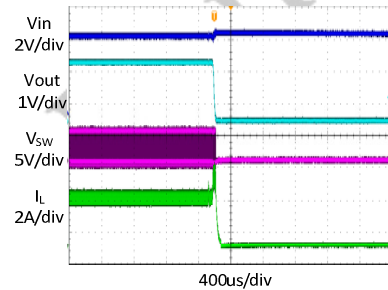

Load Transient

1.5A LOAD → 3A LOAD  
→ 1.5A LOAD

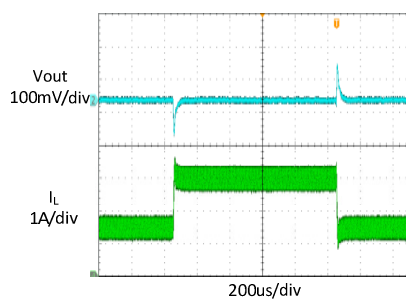

**IMPORTANT NOTICE**

- Joulwatt Technology Inc. reserves the right to make modifications, enhancements, improvements, corrections or other changes without further notice to this document and any product described herein.
- Any unauthorized redistribution or copy of this document for any purpose is strictly forbidden.
- Joulwatt Technology Inc. does not warrant or accept any liability whatsoever in respect of any products purchased through unauthorized sales channel.

JoulWatt Confidential

*Copyright © 2017EV5213 Incorporated.*

*All rights are reserved by Joulwatt Technology Inc.*