

*Parameters Subject to Change Without Notice*

### FEATURES

- 4V to 18V operating input range  
3A output current
- Up to 95% efficiency
- High efficiency (>85%) at light load
- 800kHz switching frequency
- Internal soft-start
- Input under voltage lockout
- Current run-away protection
- Output short protection
- Thermal protection
- Available in TSOT23-6 and TSOT23-8 packages

### APPLICATIONS

- Distributed Power Systems
- Networking Systems
- FPGA, DSP, ASIC Power Supplies
- Green Electronics/ Appliances
- Notebook Computers

### DESCRIPTION

The JW<sup>®</sup>5060 is a monolithic buck switching regulator based on I2 architecture for fast transient response. Operating with an input range of 4V~18V, JW5060 delivers 3A of continuous output current with two integrated N-Channel MOSFETs. The internal synchronous power switches provide high efficiency without the use of an external Schottky diode. At light loads, the regulator operates in low frequency to maintain high efficiency and low output ripples.

JW5060 guarantees robustness with output short protection, thermal protection, current run-away protection, input under voltage lockout.

JW5060 is available in TSOT23-6 and TSOT23-8 packages, which provide a compact solution with minimal external components.

### ELECTRICAL SPECIFICATIONS

Parameter	Symbol	Value	Unit
Input Voltage	VIN	5~18	V
Output Voltage	VOUT	3.3	V
Output Current	IOUT	0~3	A

### EVALUATION BOARD AND TYPICAL PERFORMANCE

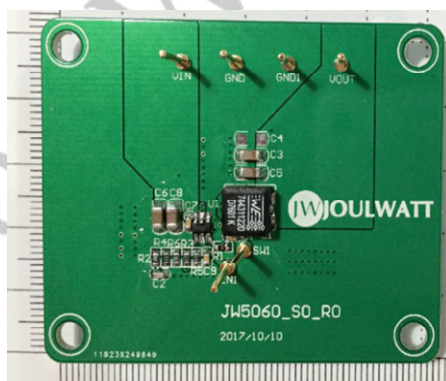

Efficiency @ Vout=3.3V

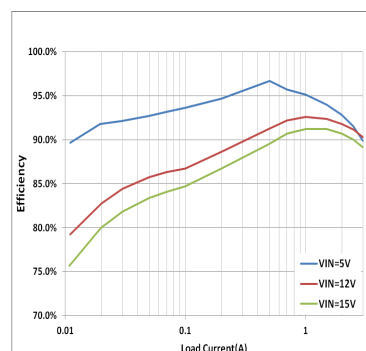

SCHEMATIC

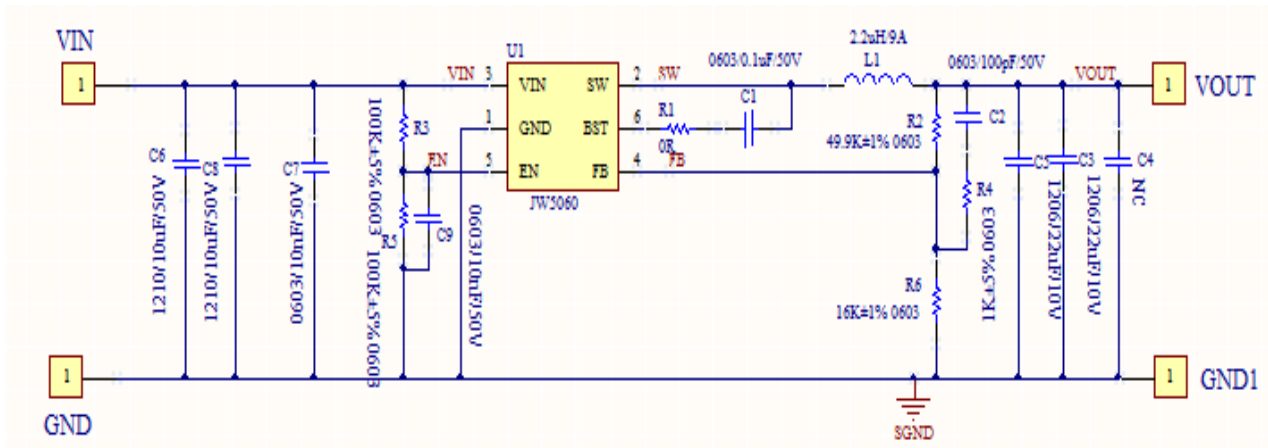

BILL OF MATERIALS

Qty.	Designator	Value	Description	Package	Manufacturer	Manufacturer P/N
1	C1	100nF	Ceramic capacitor 50V ,X7R	0603C	SAMSUNG	CL10B104K08NNNC
1	C2	100pF	Ceramic capacitor50V ,X7R	0603C	MURATA	GRM31BR72H223KW10L
2	C3,C5	22uF	Ceramic capacitor10V ,X7R	1206C	MURATA	GRM31BR72H223KW10L
0	C4	NC				
3	C6,C8	10uF	Ceramic capacitor 50V ,X7R	1206C	MURATA	GRM31BR72H223KW10L
1	C7,C9	10nF	Ceramic capacitor 50V ,X7R	0603C	MURATA	GRM31BR72H223KW10L
1	L1	2.2uH/9A	Inductor		WURTH	7447786122
1	R1	0	Resistor,1%	0603R	uniohm	0805F3001T5E
1	R2	49.9k	Resistor,1%	0603R	uniohm	0805F3001T5E
2	R3,R5	100k	Resistor,5%	0603R	uniohm	0805F3001T5E
1	R4	1k	Resistor,5%	0603R	uniohm	0805F3001T5E
1	R6	16k	Resistor,1%	0603R	uniohm	0805F3001T5E
1	VIN	5V~18V		TEST-Pole		
1	VOUT	3.3V/3A		TEST-Pole		
1	JW5060	18V/3A	Buck	TSOT23-6	Joulwatt	JW5060

## PRINTED CIRCUIT BOARD LAYEROUT

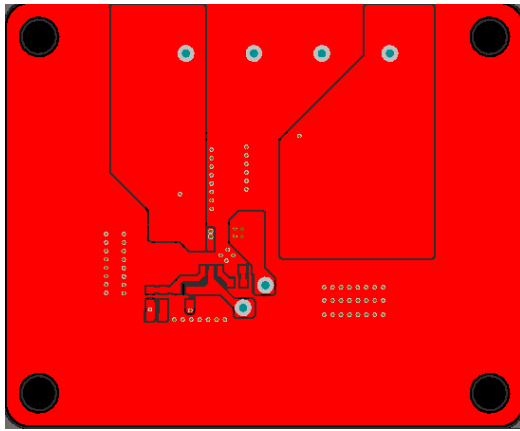

Figure1—Top Layer

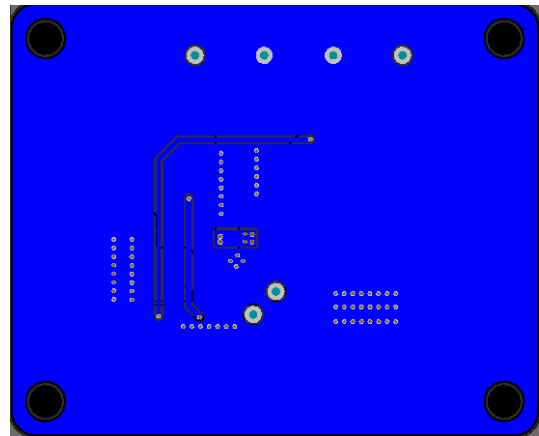

Figure2—Bottom Layer

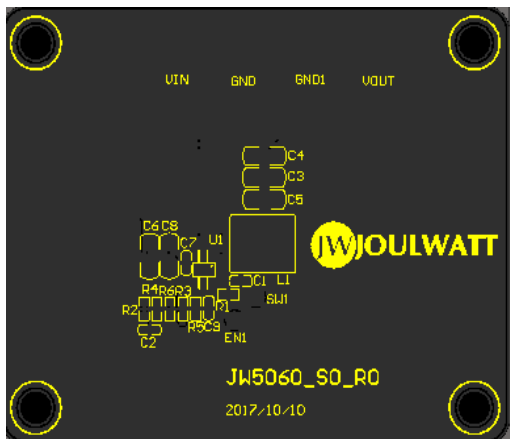

Figure3—Top Silk Layer

## QUICK START GUIDE

1. Connect the positive terminal and negative terminal of the load to Vout and GND of EVB, respectively.
2. Connect a power supply between VIN and GND with the supply in “OFF” state. Set the output voltage of the power supply to 5V~18V.
3. Turn on the power supply and the evaluation board starts operating in normal condition.
4. The output voltage can be adjusted by varying the R6 and R2 on EVB.  
For example: Fixed R6 to 16K, when adjusting the output voltage to 5V,  
 $R2 = V_{out} / 0.8 * R6 - R6$ .

For more information, please refer to the datasheet of JW5060.

TYPICAL PERFORMANCE CHARACTERISTICS

Vin =12V, Vout = 3.3V, L = 2.2μH, Cout = 44μF, TA = +25°C, unless otherwise noted

Steady State Test

VIN=12V, Vout=3.3V  
Iout=3A

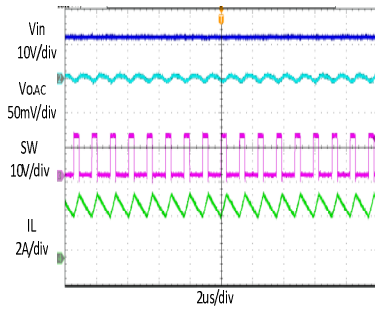

Startup through Enable

VIN=12V, Vout=3.3V  
Iout=3A(Resistive load)

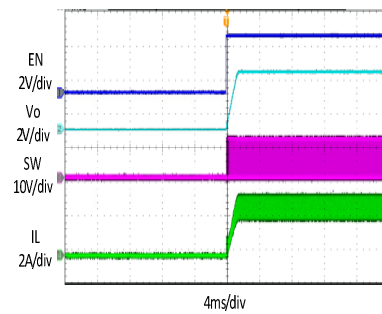

Shutdown through Enable

VIN=12V, Vout=3.3V  
Iout=3A (Resistive load)

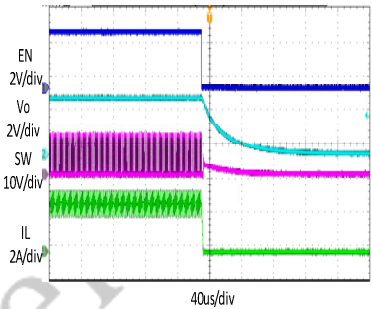

Heavy Load Operation

3A LOAD

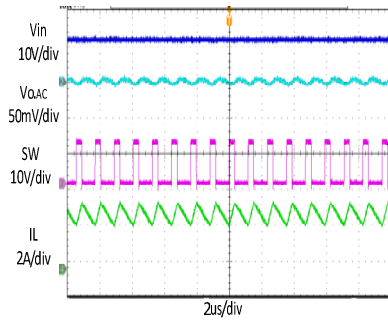

Medium Load Operation

0.3A LOAD

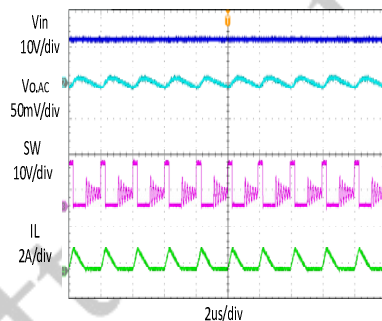

Light Load Operation

0 A LOAD

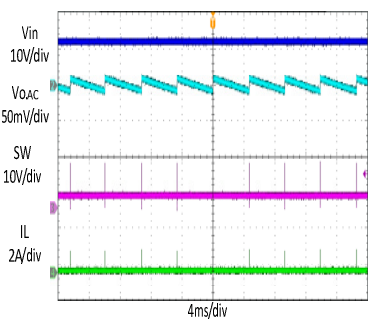

Short CircuitProtection

VIN=12V, Vout=3.3V  
Iout=3A- Short

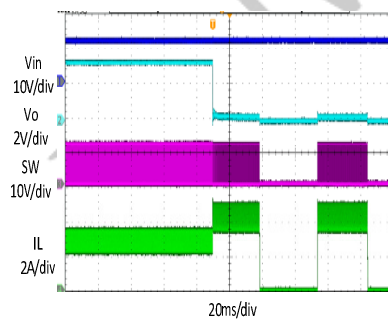

Short CircuitRecovery

VIN=12V, Vout=3.3V  
Iout= Short-3A

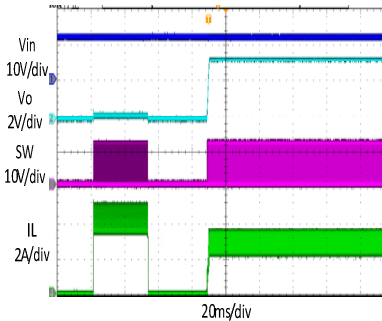

Load Transient

C2=330pF,R4=1k  
0.3A LOAD → 3A LOAD → 0.3A LOAD

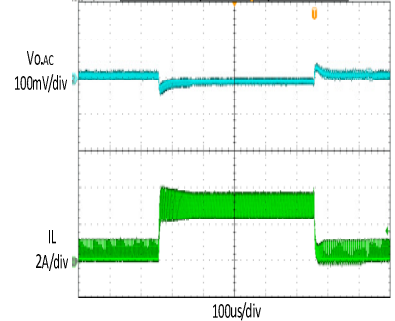

**IMPORTANT NOTICE**

- Joulwatt Technology Inc. reserves the right to make modifications, enhancements, improvements, corrections or other changes without further notice to this document and any product described herein.
- Any unauthorized redistribution or copy of this document for any purpose is strictly forbidden.
- Joulwatt Technology Inc. does not warrant or accept any liability whatsoever in respect of any products purchased through unauthorized sales channel.

JoulWatt Confidential

*Copyright © 2017 EV5060\_S0\_R0 Incorporated.*

*All rights are reserved by Joulwatt Technology Inc.*